

Data Sheet



Article number: 23020344163

Description: E+G Fingergreb MBT.50-B-8-C3, grey centre cap

Measures

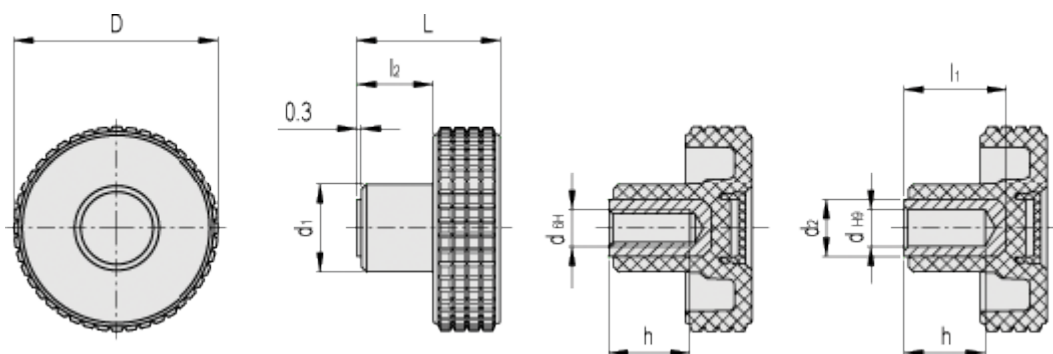

D	= 50	l2 = 16
d1	= 20	
d2	= 15	
dH6	= -	
dH9	= 8	
h	= 20	
L	= 33	
l1	= 25	